



THE 2

ACTIVE TOURER
GRAN TOURER

THE BMW 2 SERIES ACTIVE TOURER AND THE BMW 2 SERIES GRAN TOURER.



INNOVATION AND TECHNOLOGY.



18 Dynamics and efficiency
19 Powertrain and suspension



20 Driver assistance
21 Safety



22 Connectivity and infotainment
23 Comfort and functionality

EQUIPMENT.

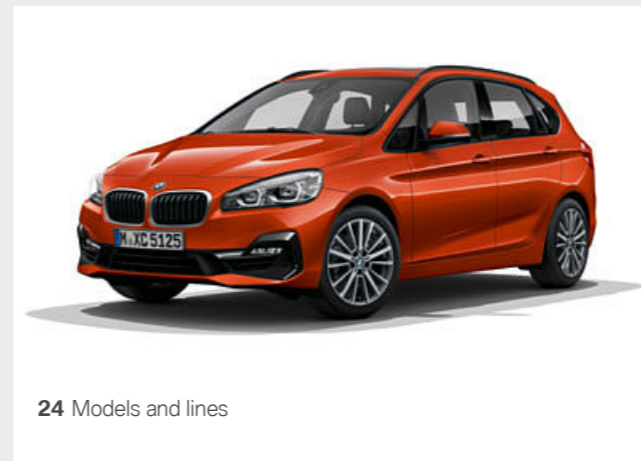

24 Models and lines

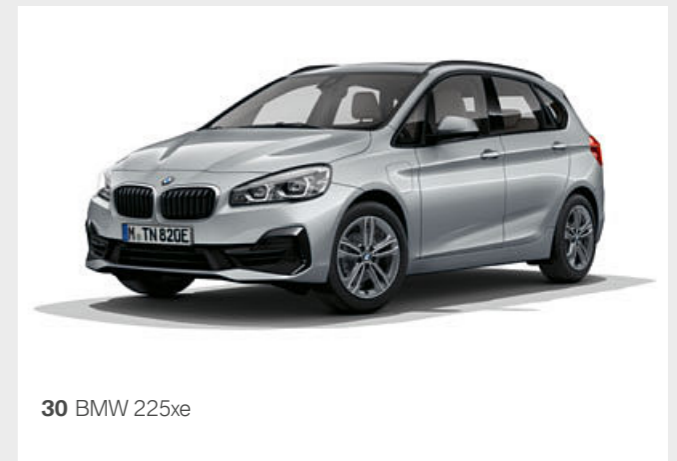

30 BMW 225xe



32 Additional equipment

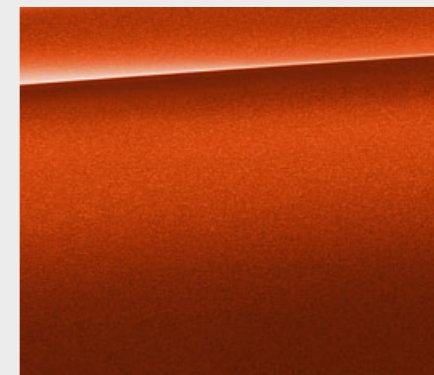

36 Exterior colours

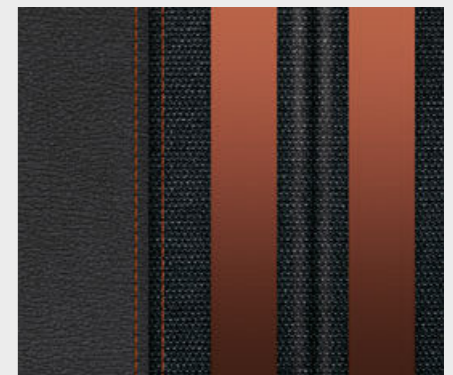

38 Interior colours

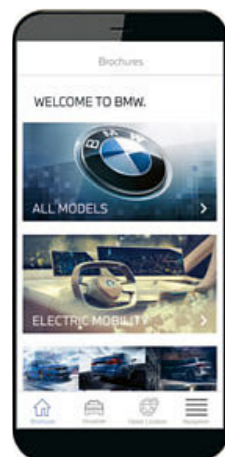

YOUR NEW SPEED DATING APP.

DOWNLOAD NOW THE BMW BROCHURES APP FROM YOUR APP STORE AND DISCOVER DRIVING PLEASURE!

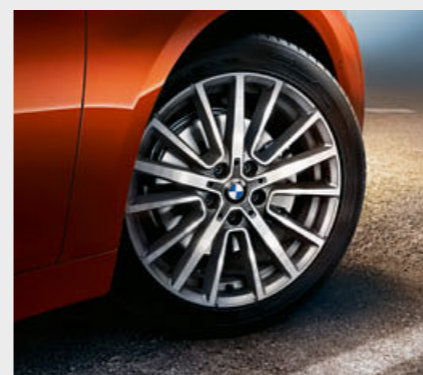

40 Wheels and tyres



41 Original BMW Accessories

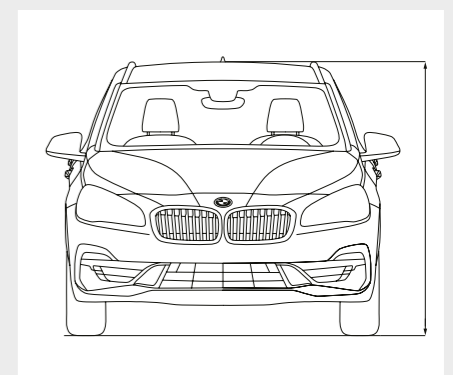

42 Technical data



FOR EVERYONE
TO HAVE FUN.

FOR THE WE IN YOU.

LOVE AT THE FIRST METRE.

DYNAMIC EXTERIOR DESIGN || 18" LIGHT ALLOY WHEELS¹ || ENLARGED TAILPIPES ||
STEPTRONIC DOUBLE CLUTCH TRANSMISSION^{1,*} || BMW xDRIVE



¹ Available as optional equipment.

* The availability of some equipment features and functions depends on engine variants or additional options. The market and production availability may vary. You can find detailed information about terms, standard and optional equipment at www.bmw.com or at your BMW Partner.



BODYGUARD INCLUDED.

NUMEROUS BMW CONNECTED DRIVE SERVICES^{1,*} FOR SAFETY AND COMFORT, E.G. TIME-TO-LEAVE NOTIFICATION* II BMW CONCIERGE SERVICE^{1,*} II BMW HEAD-UP DISPLAY^{1,2,*}

¹ Available as optional equipment.

² The information in the BMW Head-Up Display is not fully visible when viewed through polarised sunglasses. Content shown will depend on the equipment options chosen. Further optional equipment is required to display specific items.

* The availability of some equipment features and functions depends on engine variants or additional options. The market and production availability may vary. You can find detailed information about terms, standard and optional equipment at www.bmw.com or at your BMW Partner.

Some ConnectedDrive Services may differ between countries. Please consult your local BMW partner for more information.



FULL CHARGE FORWARD.

BMW 225xe ACTIVE TOURER WITH INTERNAL COMBUSTION ENGINE AND ELECTRIC MOTOR || INTELLIGENT ENERGY MANAGEMENT FOR EXTRAORDINARILY HIGH EFFICIENCY AND DYNAMICS || 131 KM/H PURELY ELECTRIC TOP SPEED





HAS EVERYTHING. JUST NOT A BUZZ KILL.

BMW TWIN POWER TURBO ENGINES II M SPORT PACKAGE¹ II
ADAPTIVE LED HEADLIGHTS IN HEXAGONAL DESIGN^{1,*} II
TELEPHONY WITH WIRELESS CHARGING^{1,2,*}

¹ Available as optional equipment.

² Supports inductive charging for Qi-compatible mobile phones. Special charging cases are available from Original BMW Accessories for selected smartphones that do not support the Qi standard for inductive charging.

* The availability of some equipment features and functions depends on engine variants or additional options. The market and production availability may vary. You can find detailed information about terms, standard and optional equipment at www.bmw.com or at your BMW Partner.

Some ConnectedDrive Services may differ between countries. Please consult your local BMW partner for more information.



HAPPINESS INCREASES WHEN YOU SHARE IT.

OPTIONAL THIRD ROW OF SEATS OR A MAXIMUM OF 1905 LITRES LUGGAGE COMPARTMENT VOLUME¹ || LONGITUDINALLY ADJUSTABLE REAR SEAT^{2,3,4} || GENEROUS SPACIOUSNESS || PANORAMA GLASS ROOF²



¹ Only available for BMW 2 Series Gran Tourer.
² Available as optional equipment.
³ Not available for BMW 225xe.
⁴ Standard for BMW 2 Series Gran Tourer.

FOR A LIFE WITH A DRIVE.

SPORTY DESIGN OCCUPIES SPACE. THE BMW 2 SERIES ACTIVE TOURER AND THE BMW 2 SERIES GRAN TOURER SHOW SIZE AND AT THE SAME TIME ESPECIALLY LOOK VERY GOOD. THEY OFFER LOTS OF SPACE FOR YOUR ACTIVE LIFESTYLE, WITHOUT NEEDING TO SUBSTITUTE ANYTHING ELSE FOR IT: NEITHER IN THE BMW TYPICAL DRIVING DYNAMICS OR IN THE SPORTY AND EXPRESSIVE DESIGN.



IN ADDITION, YOU BENEFIT FROM FLEXIBILITY THAT ADAPTS TO YOUR NEEDS. REGARDLESS WHETHER YOU TRAVEL WITH SEVEN PEOPLE^{1,2} OR LOTS OF LUGGAGE: THE FUN DOESN'T REMAIN ON THE TRACK, BUT IS IN THE CENTRE – IN THE FRONT LEFT-HAND SIDE ON THE DRIVER'S SEAT. EXPERIENCE SPORTY FUNCTIONALITY. **IN THE BMW 2 SERIES ACTIVE TOURER AND THE BMW 2 SERIES GRAN TOURER.**

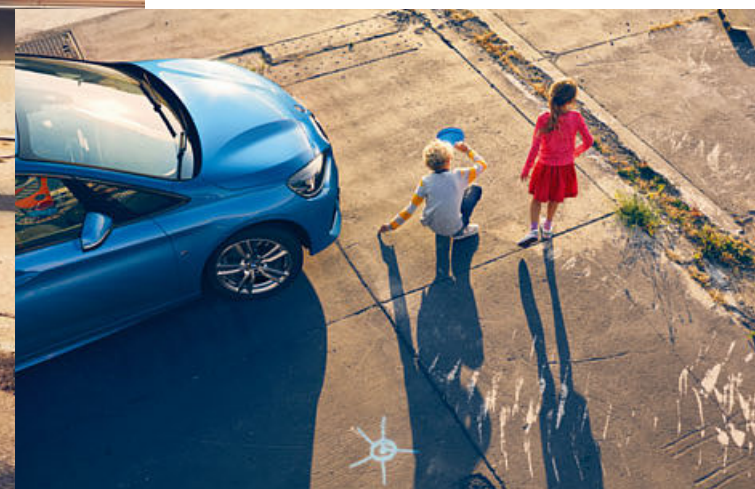

¹ Available as optional equipment.
² Only available for BMW 2 Series Gran Tourer.

DYNAMICS AND EFFICIENCY.

BMW EFFICIENTDYNAMICS.
LESS EMISSIONS. MORE DRIVING PLEASURE.

MORE POWER FROM LESS FUEL.

More power from three to 12 cylinders. Consume less, experience more – the **BMW TwinPower Turbo engines** offer the greatest possible dynamic performance with the greatest possible efficiency thanks to the newest injection systems, variable output control and sophisticated turbocharger technology. Whether diesel or petrol, and no matter how many cylinders, the engines from the BMW EfficientDynamics engine family allow markedly more agile power delivery and outstanding responsiveness even at low rpm, while being fuel-efficient and low in emissions.

MORE DRIVING PLEASURE, LESS EMISSIONS.

BMW EfficientDynamics is a technology package that includes not only the drive, but rather the whole vehicle concept and intelligent energy management. Provided as standard in every BMW, a variety of innovative technologies contribute to continuously improving efficiency. Via engine efficiency measures, electrification, lightweight construction methods and optimised aerodynamics, BMW has managed to reduce the CO₂ emissions of its fleet significantly.

MORE DYNAMICS, LESS WEIGHT.

Lower weight with intelligent lightweight construction. Special consideration for every last detail – intelligent lightweight construction means that the optimal material is found and implemented for each part of the vehicle. With extremely light high-tech materials such as aluminium and carbon fibre, **BMW EfficientLightweight** is pursuing the goal of minimising vehicle weight. That leads to even more dynamic performance, increased stability and heightened safety and comfort.



AUTOMATIC START/STOP FUNCTION

The Automatic Start/Stop function¹ switches off the engine when the vehicle comes to a temporary standstill (e.g. at traffic lights or in a traffic jam), which can reduce overall fuel consumption. When the driver presses down on the clutch (manual transmission) or takes their foot off the brake (Steptronic transmission), the engine automatically starts up again in a fraction of a second.

DRIVING EXPERIENCE CONTROL INCL. ECO PRO MODE

The Driving Experience Control lets the driver choose between the standard COMFORT mode, ECO PRO Mode which is geared towards efficiency, and SPORT mode which enables even more dynamic driving. ECO PRO mode adjusts the characteristics of the accelerator, Steptronic transmission, if present, and the heating/air conditioning settings to make the drive as fuel-efficient as possible.

OPTIMUM SHIFT INDICATOR

The Optimum Shift Indicator¹ shows the most efficient gear for a given driving situation. In all BMW models, the display informs the driver of the current gear and gives shifting recommendations. This noticeably lowers fuel consumption through perfectly timed gearshifts, particular in urban environments and over long distances.

IN THE BMW 2 SERIES ACTIVE TOURER AND GRAN TOURER.

POWERTRAIN AND SUSPENSION.

Innovation and Technology 18 | 19



THE ENGINE HIGHLIGHTS OF THE BMW 2 SERIES ACTIVE TOURER AND THE BMW 2 SERIES GRAN TOURER

BMW 218i Active Tourer

BMW TwinPower Turbo 3-cylinder petrol engine with 100 kW (136 hp) and 220 Nm torque
Acceleration 0–100 km/h: 9.3 s [9.3] s
Top speed: 205 km/h [205] km/h
Combined fuel consumption: 5.6–5.9 [5.2–5.4] l/100 km
Combined CO₂ emissions: 129–134 [120–124] g/km

BMW 220d xDrive Gran Tourer

BMW TwinPower Turbo 4-cylinder diesel engine with 140 kW (190 hp) and 400 Nm torque
Acceleration 0–100 km/h 5-seater | 7-seater: [7.8|8.0] s
Top speed 5-seater | 7-seater: [218|218] km/h
Combined fuel consumption 5-seater | 7-seater: [4.9–5.1|5.0–5.2] l/100 km
Combined CO₂ emissions 5-seater | 7-seater: [129–135|132–138] g/km

The intelligent **BMW xDrive all-wheel drive system** smoothly and variably distributes drive power to the front and rear wheels for maximum traction, driving dynamics and safety in every driving situation. For even better agility, the electronically controlled power distribution for instance counterbalances oversteer or understeer on bends.

The **Performance Control** intervenes through engine control and controlled braking when turning, so that more power is distributed to the outer wheels and less to the inner wheels. This means that the vehicle practically turns itself, thus increasing driving safety and comfort.

The **Driving dynamics control systems** support the driver in all difficult driving situations. The ABS prevents the wheels from being blocked, ensuring the car can be steered even during emergency braking. The anti-skid system Dynamic Stability Control (DSC) counteracts loss of grip in the wheels, automatically braking individual wheels.

The optional Variable **sport steering**^{1,2} with Servotronic creates a direct and agile steering response and ensures less physical effort is required to turn the wheel. It reacts to the angle of the steering wheel with varying steering ratios. This improves handling when driving more dynamically and reduces the effort needed to steer when parking and turning.

The **Adaptive suspension**^{1,2} combines driving dynamics and ride comfort with a high degree of safety. The driver has the option of preselecting the damper characteristics via the Driving Experience Control. Along with the standard COMFORT setting, SPORT mode is also available.

M Sport suspension^{1,2} – which includes a chassis which is lowered by 10 millimetres – is characterised by an athletic suspension design. In addition to shorter bearing springs, it also encompasses tighter damper settings.

¹ Not available for BMW 225xe.
² Available as optional equipment.

Further information on fuel consumption and CO₂ emissions can be found in technical data or consult your local BMW partner.

The figures for performance, fuel consumption and CO₂ emissions refer to vehicles with standard transmission. Figures in [] are for vehicles with Steptronic transmission.

DRIVER ASSISTANCE.



The safety package **Driving Assistant^{1,2,*}** includes camera-based assistance systems, such as Lane Departure Warning, Collision Warning, High-beam Assistant and Speed Limit Info. The Collision Warning and Pedestrian Warning with light city braking function warns of collisions at speeds between 10 and 60 km/h, while the Lane Departure Warning causes the steering wheel to vibrate as a warning when the lane is unintentionally changed at 70 km/h or over.

Speed Limit Info including No-overtaking indicator^{1,*} detects current speed limits and no-overtaking zones and shows them on the Info Display in the instrument cluster and on the BMW Head-Up Display^{1,3,*}.

The **Lane Departure Warning^{1,*}** detects lane markings and alerts the driver before an unintentional lane change at speeds above around 70 km/h by means of vibrations in the steering wheel. If the indicator is activated, meaning that a change of lane is intended, no warning is given.

The **Driving Assistant Plus^{1,2,*}** equipment provides a clear improvement in safety and comfort. It includes the Collision Warning and Pedestrian Warning with light city braking function, Lane Departure Warning, the High-beam assistant, the speed limit info and the camera-based cruise control with Stop&Go function.

The full-colour **BMW Head-Up Display^{1,3,*}** projects relevant driving information onto a panel in the driver's field of vision, which means they can remain focused on the road. Current speed, directions from the navigation system, Speed Limit Info incl. no-overtaking indicator and telephone and entertainment lists, among other things are displayed, depending on the equipment.

The **Parking assistant^{1,4,*}** makes parallel parking easier. The system works by measuring potential spaces while driving past them at a low speed. When a suitable space has been found, the Parking Assistant takes over steering, while you are responsible for selecting the correct gear, as well as pressing the accelerator and brake.

¹ Available as optional equipment.

² Function may be limited in darkness, fog or bright glare.

³ The information in the BMW Head-Up Display is not fully visible when viewed through polarised sunglasses. The exact content shown will depend on the equipment options chosen. Further optional equipment is required for content to be displayed.

⁴ The driver is responsible for constantly monitoring the automated parking procedure in accordance with local road laws.

* The availability of some equipment features and functions depends on engine variants or additional options. The market and production availability may vary. You can find detailed information about terms, standard and optional equipment at www.bmw.com or at your BMW Partner.

SAFETY.

■ Standard equipment □ Optional equipment

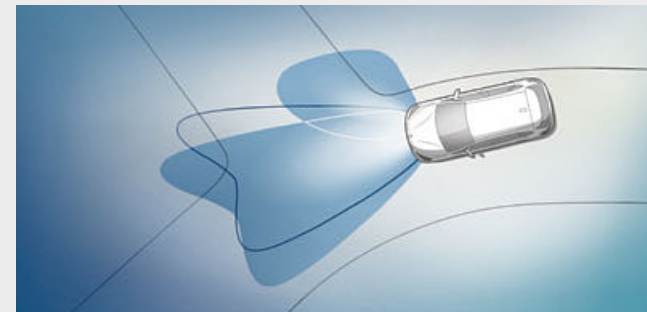

□ The **Adaptive LED headlights^{*}** include low-beam and high-beam headlights and turn indicators with full LED technology. The equipment also features BMW Selective Beam, cornering lights, daytime running lights and Adaptive headlights with variable light control for excellent illumination of the road ahead and better visibility in the dark.

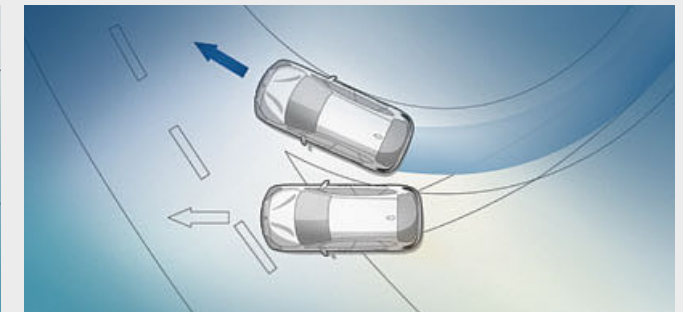

■ **Dynamic Stability Control (DSC)** continuously assesses the vehicle's movements using various sensors and stabilises the car with engine and braking regulation when unstable driving conditions are detected. Auxiliary functions include braking readiness, brake drying by the braking system in wet conditions and the Hill-Start assistant.

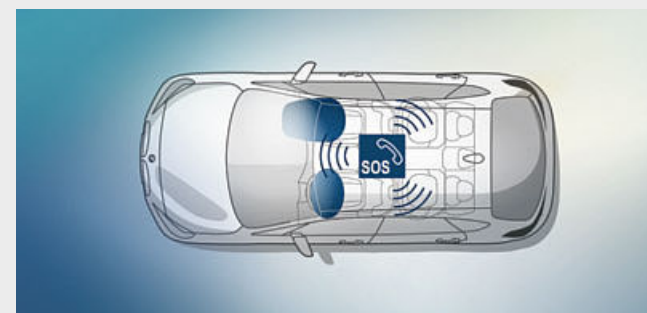

□ The **Intelligent Emergency Call^{*}** automatically establishes a connection with the nearest rescue coordination centre through the BMW call centre whenever needed – without the use of a mobile phone. It transmits information regarding the vehicle's current location and the severity of the accident. The Intelligent Emergency Call can also be triggered manually in case other road users require help, for example.

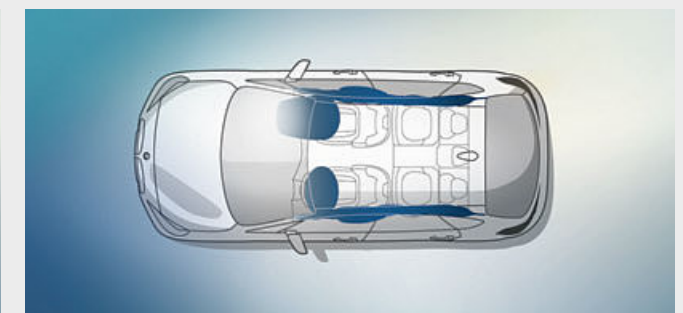

■ The **head airbags** for the first and second seat row complete the vehicle's airbag equipment. With a protective sail that deflects flying shards, they create a highly effective head protection system for the window area that also protects the rear passengers in the event of a side collision.

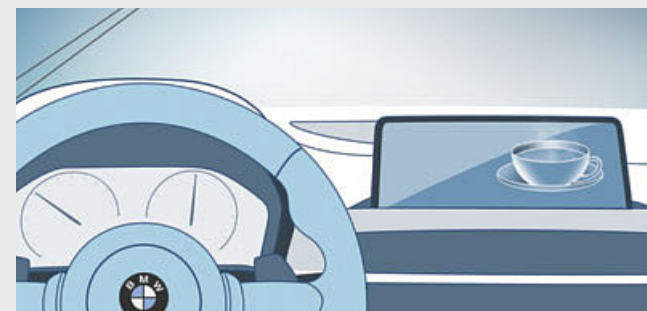

■ The **Attentiveness assistant** checks the driver's behaviour for signs of fatigue, such as inaccurate lane keeping. This system analyses the steering response and reacts to irregular driving behaviour: The Control Display then shows a message recommending the driver to take a break in order to avoid dangerous situations.

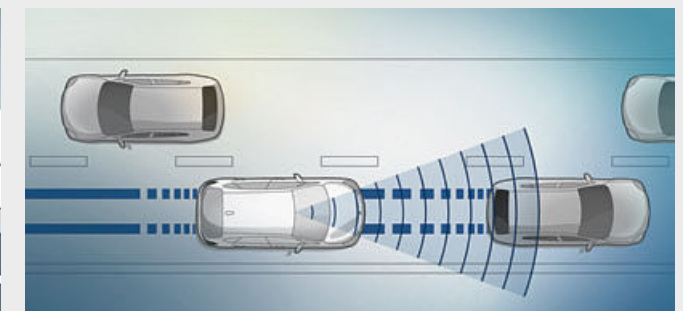

■ **Approach control warning with light city braking function^{2,*}** warns of potentially critical situations to help prevent accidents. If there is a risk of collision with a vehicle moving or standing ahead, it provides a two-stage warning and, if necessary, pre-conditions the brakes for increased responsiveness. In case of an emergency, the system initiates braking, ensuring that the collision speed is significantly reduced.

CONNECTIVITY AND INFOTAINMENT.

BMW ConnectedDrive So connected, you're free.

CONNECTED AT ALL TIMES.

Focused on the future – from the very beginning. By the 1990s, BMW had already made headway in connected mobility. Another milestone of the digital future was surpassed in 2004: vehicles with built-in SIM cards. Then came the first online functionality, Google Services and innovative display systems such as the BMW Head-Up Display. Throughout this process, the desires of the customer have always taken centre stage. In a first for a premium automobile manufacturer, BMW makes it possible to book and pay for services flexibly via the BMW ConnectedDrive Store, in the vehicle or on a computer at home. And with the introduction of the My BMW app, the Open Mobility Cloud, Remote Software Upgrades and the BMW Intelligent Personal Assistant, BMW is taking the next steps into the future of mobility.

BMW CONNECTED DRIVE STORE.

BMW ConnectedDrive opens the gate to the digital world of BMW. Use vehicle apps such as news, weather, office or online search on the go and be well informed at all times. Via the ConnectedDrive Store or directly in your BMW, you can book additional digital services such as Connected Music or Concierge Service – anytime, anywhere, easily and flexibly.

IN TOUCH 24/7, WITH BMW CONNECTED DRIVE.

Are the doors of my car really locked, when should I leave my office to arrive in time for dinner at the fancy Italian restaurant and how will I find my way there? The My BMW app can easily help you with all of these questions: it is your personal mobility assistant after all. It connects you directly with your car, giving you access before and during your trip to numerous functions, which make every drive simpler and more comfortable.



CONCIERGE SERVICE

Will it be sunny tomorrow in Rome? When is my flight and where is the best restaurant in the city? Concierge Services^{1,*} are there to help when you are travelling and can support you with any request at the touch of a button – individual, personal and fast. Wherever you are, whatever you need. The term is three years.

APPLE CAR PLAY® PREPARATION

Why go without the features of your iPhone in your BMW when you can continue operating it as usual? The preparation for Apple CarPlay^{®1,2,*} gives you remote access to telephony as well as apps like iMessage, WhatsApp, TuneIn, Spotify and Apple Music. You can also use the voice button on the steering wheel to access Siri, Apple's voice assistant.

IN THE BMW 2 SERIES ACTIVE TOURER AND GRAN TOURER.

¹ Available as optional equipment.

² Apple CarPlay[®] compatibility and supported functions depend on the model year and the software installed on the iPhone[®]. When the Apple CarPlay[®] preparation is in use, selected vehicle data is transferred to the phone. The mobile phone manufacturer is responsible for any further processing of the data.

³ Only available for BMW 2 Series Gran Tourer.

* The availability of some equipment features and functions depends on engine variants or additional options. The market and production availability may vary. You can find detailed information about terms, standard and optional equipment at www.bmw.com or at your BMW Partner.

COMFORT AND FUNCTIONALITY.



The **Comfort access system¹** allows passengers to enter the car via the front doors and to open the tailgate without having to actively use the key. The key must simply be nearby, in the driver's trouser pocket for example. To unlock the doors, it is only necessary to touch the handles or the tailgate button.

Thanks to the **versatile adjustment options for the rear seats¹**, the rear and luggage compartment can be used even more flexibly. The backrests can be folded down in a 40:20:40 ratio, or they can be positioned at either of six angles. The seats can be moved individually by 130 millimetres^{1,*} in a 60:40 ratio.

The **third row of seats^{1,3}**, with two individually foldable and forward-facing seats, offer room for two additional passengers. To ensure good access, the second row of seats can be folded forwards with the Easy-Entry function.

The **Storage compartment package** offers additional storage options in the interior and luggage compartment. Among other things, it includes a centre armrest for the rear seat with two cupholders, and nets on the front-seat backrests. A double USB port in the rear centre console and a 12V socket in the luggage compartment offer additional connection options for electrical devices.

The **Electronic parking brake** is conveniently activated via a button. Thanks to this space-saving button, the centre console has more room available for other things.

The **Sun protection glazing for the rear window¹** and tinted rear side windows prevent the interior from heating up when exposed to direct sunlight. The darker glazing behind the B-pillars absorbs more sunlight. The tinted glazing does not hinder outward visibility, but it does protect the rear seats against prying eyes.

The **Luggage-compartment separating net¹** can be attached behind the rear seats to prevent objects falling forwards into the passenger area (during hard braking, for example). When the rear seats are folded down, it can also be attached behind the front seats.

The **electric seat adjustment¹** makes it particularly convenient and easy to adjust the driver and front passenger seats. The **memory function** enables drivers to save and retrieve their desired settings for the driver's seat and exterior mirrors at the push of a button.

BASE.

Discover even more with the new BMW brochures app. Available now, for your smartphone and tablet.



■ The interior trim finishers in Oxide Silver dark matt with accent in Black high-gloss add to the modern aesthetic appeal of the cockpit, which is clearly directed towards the driver.

■ The standard seats in Cloth 'Grid' Anthracite combine a modern look with high seating comfort on every trip.

Selected base model equipment features:

- 16" light alloy wheels V-spoke style 471
- Halogen headlights
- Sport leather steering wheel
- Air conditioning
- Radio media with 6.5" LCD colour display and USB port
- Driving Experience Control incl. ECO PRO
- Seat adjustment for rear seats¹*
- Seat backrest with 40:20:40 division
- Storage compartment package



■ 16" light alloy wheels V-spoke style 471* in Reflex Silver, wheel size 7J x 16, with 205/60 R16 tyres.

LUXURY LINE.

Equipment 24 | 25

■ Standard equipment □ Optional equipment



■ The interior is dominated by modern aesthetics, which at the same time expresses the sophisticated character of the Luxury Line: The standard seats are covered with leather 'Dakota' Mocha with perforations and raise comfort to a new level. They harmonise perfectly with the interior trim finishers in fine-wood trim 'Fineline' Stream and highlight trim finishers in Pearl Chrome for an unmistakably high-quality ambience.

□ Sporty and elegant at the same time: The sport leather steering wheel with multifunction buttons integrates control elements into the horizontal steering wheel spokes for ideal accessibility.

■ 17" light alloy wheels Multi-spoke style 547, wheel size 7.5J x 17 with 205/55 R17 tyres.

Luxury Line exterior equipment:

- BMW kidney grille with twelve exclusively designed vertical slats with front sides in Chrome high-gloss
- Front bumper with specific design elements in Chrome high-gloss
- 17" light alloy wheels Multi-spoke style 547, other wheels available
- Side window surrounds and window recess finisher in Aluminium anodised, mirror base and mirror foot in Black matt
- Rear bumper with specific design elements in Chrome high-gloss

Luxury Line interior equipment:

- Door sill finishers in aluminium, front, with "BMW" lettering
- Seats in Leather 'Dakota' Black with exclusive perforations, other upholstery available
- Sport leather steering wheel incl. multifunction buttons
- Car key with Chrome detailing
- Interior trim finishers in Fine-wood trim 'Fineline' Stream with accent in Pearl Chrome, alternatively Interior trim finishers in 'Fineline' Shore with accent in Pearl Chrome, other trims available
- Exclusive LED optical fibre in the door trim
- Dashboard and centre console with contrast stitching (to match upholstery colour)

¹ Standard for BMW 2 Series Gran Tourer.

* The availability of some equipment features and functions depends on engine variants or additional options. The market and production availability may vary. You can find detailed information about terms, standard and optional equipment at www.bmw.com or at your BMW Partner.

SPORT LINE.

Discover even more with the new BMW brochures app. Available now, for your smartphone and tablet.

■ Standard equipment □ Optional equipment



□ The sport leather steering wheel with multifunction buttons sets a sign in the interior that is just as sporty as the interior trim finishers in Aluminium, finely brushed lengthwise with accent in Pearl Chrome.



■ Pure athletics on all seats: The sport seats in Cloth/Sensatec combination in Anthracite with orange accent provide a stable hold even in dynamic curves.

Sport Line exterior equipment:

- BMW kidney grille with vertical slats, with front sides in Black high-gloss
- Front bumper with specific design elements in Black high-gloss
- 17" light alloy wheels Double-spoke style 549; other wheels available
- Mirror caps in body colour, alternatively in Black
- Rear bumper with specific design elements in Black high-gloss

Sport Line interior equipment:

- Door sill finishers in aluminium, front, with "BMW" lettering
- Sport seats for driver and front passenger in Cloth/Sensatec combination Anthracite/accnt Grey or accent Orange; other upholsteries available
- Sport leather steering wheel incl. multifunction
- Car key with Chrome detailing
- Interior trim finishers in Black high-gloss with accent in Pearl Chrome; other trims available
- Exclusive LED optical fibre in the door trims
- Dashboard and centre console with contrast stitching (to match upholstery colour)



■ 17" light alloy wheels Double-spoke style 549, with runflat tyres, wheel size 7.5J x 17 with 205/55 R17 tyres.

M SPORT PACKAGE.

Discover even more with the new BMW brochures app. Available now, for your smartphone and tablet.

powered by 

■ Standard equipment □ Optional equipment



■ The M leather steering wheel with multifunction buttons and M interior trim finishers in Aluminium Hexagon with highlight trim finisher Pearl Chrome combine very sporty functionality with dynamic ambience.



□ Sport seats in leather 'Dakota' Black with perforation and blue accents create a pure race track atmosphere in the interior.

M Sport package exterior equipment:

- M Aerodynamics package with front apron, side sills and rear apron with diffuser insert in Dark Shadow metallic
- BMW kidney grille with longitudinal struts, with end faces in Black high-gloss
- LED fog lights*
- 17" M light alloy wheels Double-spoke style 483 M, alternatively 18" M light alloy wheels Double-spoke style 486 M
- M Sport suspension*, lowered, alternatively standard suspension
- M high-gloss Shadow Line, alternatively exterior trim, Chromeline
- M designation on the sides
- Exclusive paintwork in M Misano Blue metallic; other paintwork available

M Sport package interior equipment:

- M front entry sills, M driver footrest
- Sport seats for driver and front passenger in Anthracite Cloth/Sensatec with Grey highlights; other upholsteries available
- M leather steering wheel with multifunction buttons
- M anthracite headliner
- Dashboard and centre console with contrast stitching
- M interior trim finishers Aluminium Hexagon with highlight trim finisher Pearl Chrome; other trims available
- Gear lever with M designation*
- Exclusive LED optical fibre in the door trims
- Vehicle key with exclusive M designation



■ 17" M light alloy wheels Double-spoke style 483 M, 7.5J x 17, 205/55 R17 tyres.



□ 18" M light alloy wheels Double-spoke style 486 M in Ferric Grey, gloss lathed, wheel size 8J x 18 with 225/45 R18 tyres.

*The availability of some equipment features and functions depends on engine variants or additional options. The market and production availability may vary. You can find detailed information about terms, standard and optional equipment at www.bmw.com or at your BMW Partner.

BMW 225xe.

The BMW 225xe Active Tourer combines as a plug-in hybrid a BMW TwinPower Turbo 3-cylinder petrol engine with 92 kW (125 hp) and a 70 kW (95 hp) electric motor, resulting in a system output of 162 kW (220 hp). The standard electric xDrive automatically provides excellent traction and dependable directional stability. Intelligent energy management coordinates the interaction of all BMW drive components. Depending on the selected drive mode and the battery's charging status, the electric motor can power the vehicle by itself or support the internal combustion engine. During coasting and braking, the motor even transforms kinetic energy into electric energy, which is stored in the lithium-ion high-voltage battery for use by the electric drive system. The top electric speed is 135 km/h. The vehicle can be recharged at home using any domestic power socket or even more conveniently with a BMW Wallbox¹. When on the move, the BMW can be recharged at public charging stations.

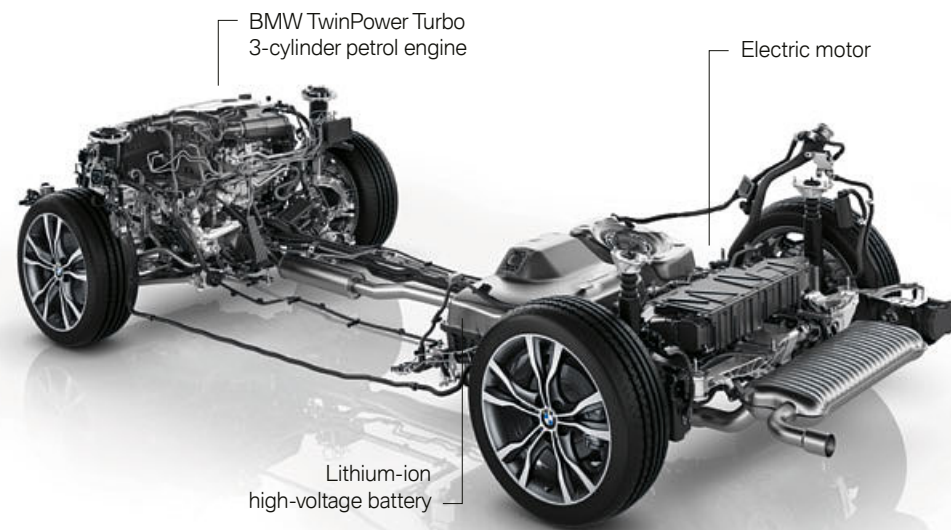

The port for external charging of the high-voltage battery is located behind a flap on the vehicle's front side panel on the left. The charging port is protected from the elements by a special seal. The LED light ring around the port indicates the vehicle's current charge status.



BMW eDrive technology combines the best of both worlds: purely electric, locally emission-free driving (e.g. in urban areas), along with a dynamic driving performance and a great possible range. Intelligent energy management controls the interaction between the electric motor and the combustion engine, deploying both with impressive efficiency.

¹ Equipment available as an option from Original BMW Accessories.

Quoted performance, fuel consumption and CO₂ emissions figures refer to vehicles with standard transmission. Figures in [] refer to vehicles with Steptronic transmission.

Please see technical data or consult your local BMW partner for further information on fuel consumption and CO₂ emissions.

ADDITIONAL EQUIPMENT.

Discover even more with the new BMW brochures app. Available now, for your smartphone and tablet.

■ Standard equipment □ Optional equipment



□ When open, the Panorama glass roof provides a great deal of fresh air. Closed, it creates a bright, light-flooded atmosphere in the interior. It opens and closes completely automatically at the push of a button, or via the remote control, and is equipped with slide and lift functions, a roller sunblind and wind deflector.



□ The third row of seats¹, with two individually foldable and forward-facing seats, offer room for two additional passengers.

■ The rear seat bench has three full seats. The backrests can be folded in a 40:20:40 ratio.



□ The Adaptive LED headlights* include low-beam and high-beam headlights and turn indicators with full LED technology. The equipment also features BMW Selective Beam, cornering lights, daytime running lights and Adaptive headlights with variable light control for excellent illumination of the road ahead and better visibility in the dark.



□ LED fog lights* increase short-range visibility in fog or precipitation, improving safety. The colour of the light they emit is remarkably similar to daylight. They also consume little energy and have a very long lifespan. The fog lights give the front of the car a high-tech, modern appearance.



□ The 8-speed Steptronic Sport transmission* offers incredibly sporty gear changes. Whether automatic or manual using gearshift paddles or gear lever.



□ Thanks to its tightly spaced gear ratios and fast engine speed transitions, the 8-speed Steptronic transmission* ensures greater driving comfort, smoother gearshifts and low fuel consumption.

□ The 7-speed Steptronic transmission* with double clutch technology offers particularly smooth gearshifts and outstanding driving comfort, all with low fuel consumption.

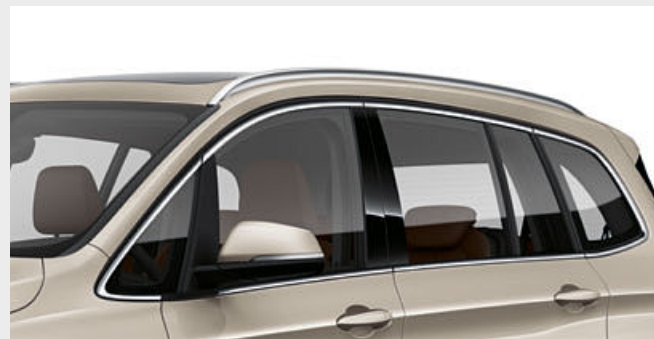

□ The Roof rails in Aluminium satinated provide the base for a multifunctional BMW roof rack unit.

□ The Chrome Line Exterior features attractive accents with elements in highly polished aluminium and contrasts in black matt.



□ The Comfort access system allows passengers to enter the car via the front doors and to open the tailgate without having to actively use the key. The key must simply be nearby, in the driver's trouser pocket for example. To unlock the doors, it is only necessary to touch the handles or the tailgate button.



■ The Storage compartment package offers a multitude of additional storage options in the interior and luggage compartment.

□ The Luggage-compartment separating net behind the second row of seats prevents objects from falling forwards into the passenger area.



□ The rear seat bench² has three full seats. The backrests can be folded down in a 40:20:40 ratio, or they can be positioned at either of six angles. Also on board: three height-adjustable headrests, three-point seat belts for all seats and an ISOFIX child seat attachment for the outer seats.

¹ Only available for BMW 2 Series Gran Tourer.
² Standard for BMW 2 Series Gran Tourer.

*The availability of some equipment features and functions depends on engine variants or additional options. The market and production availability may vary. You can find detailed information about terms, standard and optional equipment at www.bmw.com or at your BMW Partner.

ADDITIONAL EQUIPMENT.

Discover even more with the new BMW brochures app. Available now, for your smartphone and tablet.

■ Standard equipment □ Optional equipment



□ The full-colour BMW Head-Up Display^{1,*} projects relevant driving information onto a panel in the driver's field of vision, which means they can remain focused on the road. Current speed, directions from the navigation system, Speed Limit Info incl. no-overtaking indicator and telephone and entertainment lists, among other things are displayed, depending on the equipment.



□ Navigation Plus* features a BMW Head-Up Display¹, an iDrive Controller, a built-in 8.8" touch display and an instrument cluster with high-resolution 5.7" TFT display. The system is operated intuitively using either the iDrive Controller, the direct menu control buttons and six or eight functional bookmarks, Intelligent Voice Control or the touchscreen with interactive tiles.



□ The Automatic air conditioning with 2-zone control* and automatic target temperature control features separate controls for you and your front passenger. It also includes automatic air recirculation control, a micro active carbon filter, a condensation and solar sensor, as well as rear air vents.



□ The Harman Kardon 7.1 Surround Sound system, with twelve speakers optimally designed to suit the interior's sound characteristics, guarantees an exceptional music experience. Tweeters and subwoofers deliver a brilliant, powerful range of sound. Elegant aluminium loudspeaker fronts feature "Harman/Kardon" lettering for a high-class look.



□ The Rear view camera* enables improved orientation when reversing at speeds below 15 km/h, for example when parking. It shows the area behind the car on the Control Display. Interactive track lines for measuring distance and turning circles assist you when manoeuvring. Obstacles are marked in colour.



□ The Lane Departure Warning* detects lane markings and alerts the driver before an unintentional lane change at speeds above around 70 km/h by means of vibrations in the steering wheel. If the indicator is activated, meaning that a change of lane is intended, no warning is given.



□ Telephony with wireless charging^{2,*} includes a wireless charging dock and an additional USB port. A roof aerial connection improves mobile reception. Two mobile telephones and an audio player can be connected simultaneously via Bluetooth. In addition, there is Bluetooth Office.

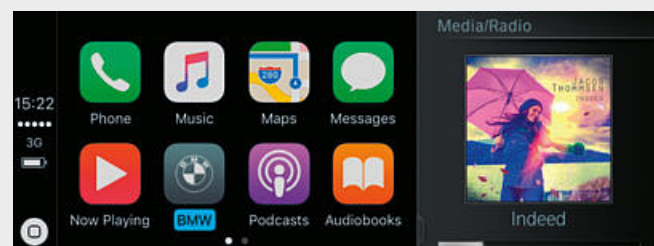

□ Why go without the features of your iPhone in your BMW when you can continue operating it as usual? The preparation for Apple CarPlay^{3,*} gives you remote access to telephony as well as apps like iMessage, WhatsApp, TuneIn, Spotify and Apple Music. You can also use the voice button on the steering wheel to access Siri, Apple's voice assistant.



□ The Driving Assistant Plus^{4,*} equipment provides a clear improvement in safety and comfort. It includes the Collision Warning and Pedestrian Warning with light city braking function, Lane Departure Warning, the High-beam assistant, the speed limit info and the camera-based cruise control with Stop&Go function.



□ The Parking Assistant^{5,*} makes parallel parking easier. The system works by measuring potential spaces while driving past them at a low speed. When a suitable space has been found, the Parking Assistant takes over steering, while you are responsible for selecting the correct gear, as well as pressing the accelerator and brake.

¹ The information in the BMW Head-Up Display is not fully visible when viewed through polarised sunglasses. The exact content shown will depend on the equipment options chosen. Further optional equipment is required for content to be displayed.
² Supports inductive charging for Qi-compatible mobile phones. Special charging cases are available from Original BMW Accessories for selected smartphones that do not support the Qi standard for inductive charging.

³ Apple CarPlay[®] compatibility and supported functions depend on the model year and the software installed on the iPhone[®]. When the Apple CarPlay[®] preparation is in use, selected vehicle data is transferred to the phone. The mobile phone manufacturer is responsible for further data processing.
⁴ Function may be limited in darkness, fog or bright glare.

⁵ The driver is responsible for constantly monitoring the automated parking procedure in accordance with local road laws.

* The availability of some equipment features and functions depends on engine variants or additional options. The market and production availability may vary. You can find detailed information about terms, standard and optional equipment at www.bmw.com or at your BMW Partner. Some ConnectedDrive Services may differ between countries. Please consult your local BMW partner for more information.

EXTERIOR COLOURS.

Discover even more with the new BMW brochures app. Available now, for your smartphone and tablet.

■ Standard equipment □ Optional equipment



□ Non-metallic 300 Alpine White¹

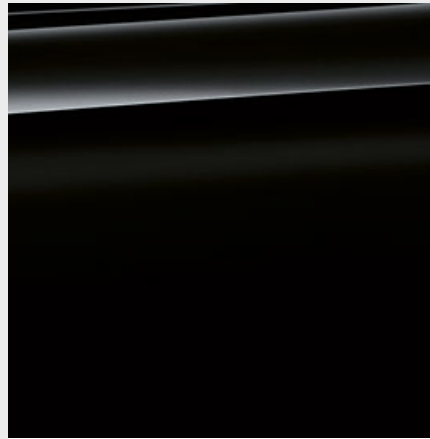

■ Non-metallic 668 Black

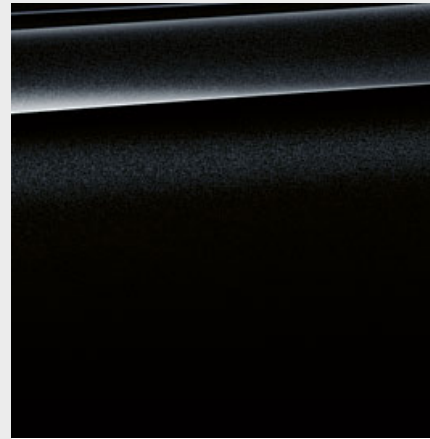

□ Metallic 475 Sapphire Black²



□ Metallic A83 Glacier Silver²



□ Metallic C1M Phytionic Blue³



□ Metallic A96 Mineral White²



□ Metallic B39 Mineral Grey²



□ Metallic A72 Cashmere Silver³

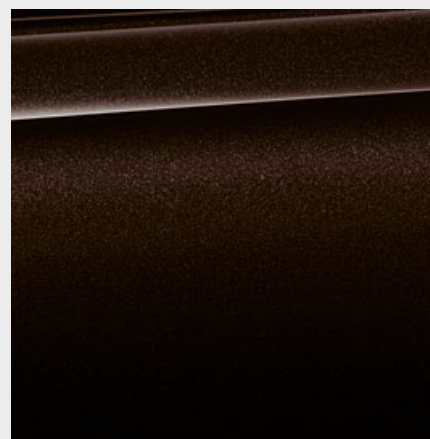

□ Metallic B53 Sparkling Brown



□ Metallic C10 Mediterranean Blue⁴



□ Metallic C1X Sunset Orange

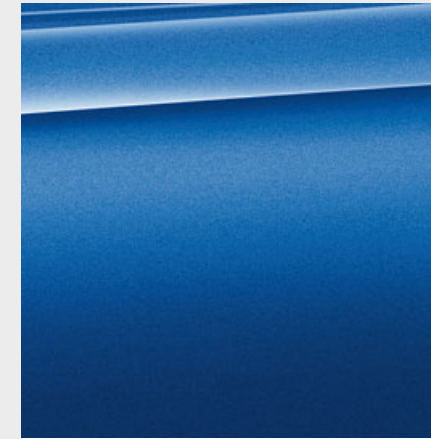

□ Metallic B45 M Estoril Blue^{4,5}

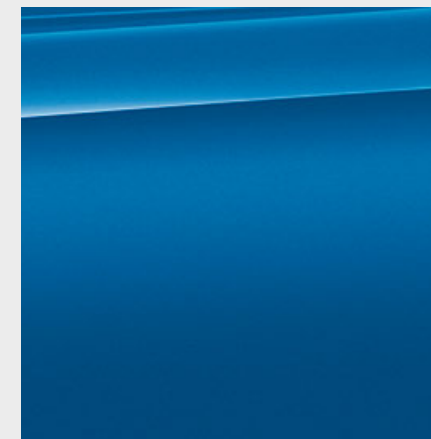

□ Metallic C1D M Misano Blue metallic^{3,5}

M SPORT PACKAGE

[Colour samples] These colour samples are intended as an initial guide to the colours and materials available for your BMW. However, experience has shown that printed versions of paint, upholstery and interior trim colours cannot in all cases faithfully reproduce the

appearance of the original colour. Please discuss your preferred colour choices with your BMW partner or dealership. There you can also see original samples and be assisted with special requests.

¹ Available as standard for the M Sport package.
² Also optionally available for the M Sport package.
³ Only available for BMW 2 Series Gran Tourer.
⁴ Only available for BMW 2 Series Active Tourer.
⁵ Exclusively available for the M Sport package.

The availability of some equipment features and functions depends on engine variants or additional options. The market and production availability may vary. You can find detailed information about terms, standard and optional equipment at www.bmw.com or at your BMW Partner.

INTERIOR COLOURS.

Discover even more with the new BMW brochures app. Available now, for your smartphone and tablet.

■ Standard equipment □ Optional equipment

CLOTH

Available with



■ Base

Cloth 'Grid'
EGAT Anthracite*

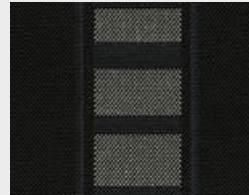

□ Base

Cloth 'Race'
ERL1 Anthracite,
Grey highlight*

CLOTH-SENSATEC COMBINATION

Available with



■ Sport Line

Cloth/Sensatec
combination
KFIX Anthracite,
accent Orange



□ Base
■ Sport Line
■ M Sport package

Cloth/Sensatec
combination
KFL1 Anthracite,
accent Grey*

INTERIOR TRIM

Available with



■ Base

4FS Oxide Silver
dark matt, highlight
trim finisher Black
high-gloss

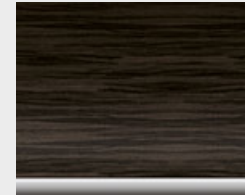

□ Base
■ Luxury Line
□ Sport Line
□ M Sport package

4LR Fine-wood trim
Fineline Stream,
highlight trim
finishers Pearl
Chrome

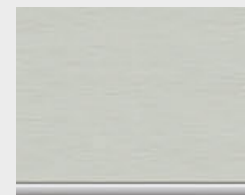

□ Base
■ Luxury Line
□ Sport Line
■ M Sport package

4LS Aluminium,
finely brushed
lengthwise, highlight
trim finishers Pearl
Chrome

SENSATEC

Available with

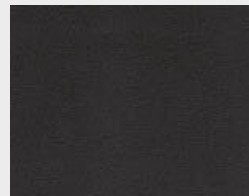

□ Base
■ Luxury Line
□ Sport Line
□ M Sport package

Sensatec
KCSW Black

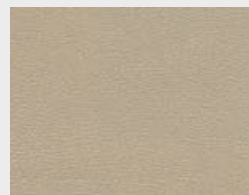

□ Base
■ Luxury Line
□ Sport Line

Sensatec
KCCX Oyster

LEATHER

Available with

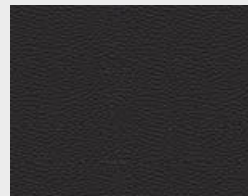

□ Base

Leather 'Dakota'
LCSW Black



■ Luxury Line
□ Sport Line
□ M Sport package

Leather 'Dakota'
PDMY Mocha
with perforations,
Walnut accent

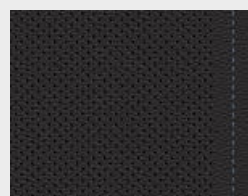

□ M Sport package

Leather 'Dakota'
PDN4 with
perforations Black,
Blue highlight



■ Luxury Line
□ Sport Line
□ M Sport package

Leather 'Dakota'
PDOA Oyster,
with perforations,
Grey highlight

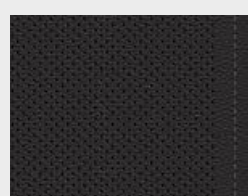

■ Luxury Line
□ Sport Line
□ M Sport package

Leather 'Dakota'
PDSW with
perforations Black
and Grey highlight



□ Base
■ Luxury Line
■ Sport Line
■ M Sport package

4LU Black high-
gloss, highlight
trim finisher Pearl
Chrome



■ M Sport package

4WE M Aluminium
Hexagon, highlight
trim finisher Pearl
Chrome

M HEADLINER

Available with

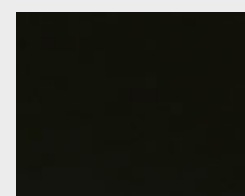

□ Base
□ Luxury Line
□ Sport Line
■ M Sport package

M headliner
775 Anthracite

Please note that even normal long or short-term use can lead to permanent upholstery damage. This can be caused in particular by non-colourfast clothing.

The interior colour is dependent on the chosen upholstery colour.

*The availability of some equipment features and functions depends on engine variants or additional options. The market and production availability may vary. You can find detailed information about terms, standard and optional equipment at www.bmw.com or at your BMW Partner.

WHEELS AND TYRES.

Discover even more with the new BMW brochures app. Available now, for your smartphone and tablet.



□ 18" light alloy wheels Star-spoke style 512 Orbit Grey, 8J x 18, 225/45 R18 tyres.



■ 16" light alloy wheels V-spoke style 471* in Reflex Silver, wheel size 7J x 16, with 205/60 R16 tyres.



■ 17" M light alloy wheels Double-spoke style 483 M¹*, 7.5J x 17, 205/55 R17 tyres.



□ 16" light alloy wheels turbine styling 472*, BMW EfficientDynamics, Orbit Grey, gloss-lathed, wheel size 7J x 16, 205/60 R16 tyres.



□ 17" light alloy wheels Double-spoke style 385 Reflex Silver, wheel size 7.5J x 17 with 205/55 R17 tyres.



□ 17" light alloy wheels V-spoke style 479 in Reflex Silver, wheel size 7.5J x 17 with 205/55 R17 tyres.



□ 17" light alloy wheels Multi-spoke style 546, wheel size 7.5J x 17 with 205/55 R17 tyres.



□ 18" light alloy wheels Y-spoke style 484 Ferric Grey, gloss-lathed, wheel size 8J x 18 with 225/45 R18 tyres.



□ 18" M light alloy wheels Double-spoke style 486 M¹ in Ferric Grey, bright turned, wheel size 8J x 18 with 225/45 R18 tyres.

ORIGINAL BMW ACCESSORIES.

Equipment 40 | 41

■ Standard equipment □ Optional equipment ○ Accessories



○ This contemporary roof box in Black with titanium silver side trims has a 420-litre capacity and fits all BMW roof rack systems. It can be opened from both sides and features triple central locking on each side which makes it easy to load and provides anti-theft locking.



○ The sporty 19" M light alloy wheels Double-spoke style 766 M are designed in Bicolour Jet Black matt, gloss-lathed, weight-optimised and feature the BMW M logo. TPMS summer complete wheel set with run-flat tyres, wheel size 8J x 19 with tyre size 225/40 R18 93Y RSC.



○ Secure base for up to five pairs of skis or four snowboards and makes loading easier especially with higher vehicles.



○ The universal holder is adjustable in terms of size and it is snapped into position into the basic carrier of the Travel & Comfort System that is available separately. It provides a secure hold for a wide range of Apple and Samsung tablets from 7" to 11" with Travel & Comfort tablet safety case. It can be rotated through 360°, tilted and fixed in the desired position.



○ The durable, anti-slip, water-resistant fitted mat with raised borders on all sides protects the luggage compartment from dirt and moisture.



○ The perfectly fitted, all-weather floor mats with a raised border and elegant design protect the front footwell against moisture and dirt.



○ The foldable Compact rear bike rack is light but sturdy and can carry up to 60 kg. It can be quickly and securely mounted on the tow ball and transport up to two bicycles or e-bikes. When folded up, it can be stored in the luggage compartment tray, safe from spray and protected in the event of a collision.

¹ Only available in conjunction with M Sport package.

* The availability of some equipment features and functions depends on engine variants or additional options. The market and production availability may vary. You can find detailed information about terms, standard and optional equipment at www.bmw.com or at your BMW Partner.

Discover the wide range of innovative solutions available for the exterior and interior, communication and information, and for transportation and the luggage compartment. Your BMW Partner is on hand to advise you on the whole range of

Original BMW Accessories and the BMW M Performance Parts product portfolio. For further information, please visit www.bmw.com

BMW 2 SERIES ACTIVE TOURER.								
TECHNICAL DATA.								
	216i	218i	220i	225i xDrive	216d	218d 218d xDrive	220d 220d xDrive	225xe

Weight									
Unladen EU (xDrive) ¹	kg	1440	1445 [1475]	[1490]	((1595))	1500 [1505]	1530 [1565] ([1620])	[1560] ([1620])	((1760))
Max. permissible weight (xDrive)	kg	1910	1920 [1945]	[1970]	((2090))	1970 [1975]	2010 [2040] ([2100])	[2045] ([2105])	((2180))
Permitted load (xDrive)	kg	545	550 [545]	[555]	(570)	545 [545]	555 [550] ([555])	[560] ([560])	((495))
Permitted trailer load, unbraked (xDrive) ²	kg	720	720 [735]	[745]	((750))	750 [750]	750 [750] ([750])	[750] ([750])	–
Permitted trailer load, braked, max. 12% gradient/max. 8% gradient (xDrive) ²	kg	1100/1100	1300/1300 [1300/1300]	[1500/1500]	((1600/1600))	1300/1300 [1300/1300]	1300/1300 ([1600/1600])	[1500/1500] ([1600/1600])	–
Luggage capacity	l	468–1510	468–1510	468–1510	468–1510	468–1510	468–1510	468–1510	400–1350

BMW TwinPower Turbo engine ⁴									
Cylinders/valves		3/4	3/4	4/4	4/4	3/4	4/4	4/4	3/4
Capacity	cm ³	1499	1499	1998	1998	1496	1995	1995	1499
Max. output/engine speed	kW (hp)/rpm	80 (109)/4300–6500	100 (136)/4500–6500	131 (178)/5000–5500	170 (231)/5000–6000	85 (116)/4000	110–100 (150–136)/4000	140 (190)/4000	92 (125)/5000–5500
Max. torque/engine speed	Nm/rpm	190/1380–3800	220/1500–4100	280/1350–4200	350/1450–4500	270/1750–2250	350/1750–2500	400/1750–2500	220/1500–3800

eDrive motor									
Max. output	kW (hp)	–	–	–	–	–	–	–	70 (95)
Max. torque	Nm	–	–	–	–	–	–	–	165
System output	kW (hp)	–	–	–	–	–	–	–	162 (220)
System torque	Nm	–	–	–	–	–	–	–	385

Lithium-ion high-voltage battery									
Battery type/net battery capacity	kWh	–	–	–	–	–	–	–	Li-ion/8.8
Electric range/Maximum total range, combined ³	km	–	–	–	–	–	–	–	59–55/– ⁷
Charging time (AC rapid charging with BMW Wallbox) ⁶	h	–	–	–	–	–	–	–	approx. 3.2

Power transmission									
Type of drive (xDrive)		Front-wheel	Front-wheel	Front-wheel	(all-wheel)	Front-wheel	Front-wheel	Front-wheel	(electric all-wheel)
Standard transmission (xDrive)		6-speed manual	6-speed manual	7-speed DCT	(8-speed Steptronic)	6-speed manual	6-speed manual (8-speed Steptronic)	8-speed Steptronic (8-speed Steptronic)	(6-speed Steptronic)

Driving performance									
Top speed (xDrive)	km/h	190	205 [205]	[229]	((235))	195 [194]	213–200 [213–203] ([211])	[224] ([222])	((202))
Top electric speed (xDrive)	km/h	–	–	–	–	–	–	–	((135))
Acceleration (xDrive) 0–100 km/h	s	11.3	9.3 [9.3]	[7.3]	((6.5))	11.1 [11.1]	9.0–9.5 [9.1–9.6] ([9.0])	[7.6] ([7.5])	((6.7))

Consumption ^{4,5} – All engines conform to the EU6 standard									
Urban (xDrive)	l/100 km	7.1–7.3	7.2–7.4 [6.4–6.5]	[6.9–7.0]	((7.7–7.8))	4.7–4.8 [4.3–4.5]	5.1–5.4 [4.9–5.1] ([5.1–5.4])	[4.8–5.0] ([5.4–5.6])	–
Extra-urban (xDrive)	l/100 km	4.8–5.0	4.7–4.9 [4.5–4.8]	[4.6–4.9]	((5.3–5.5))	3.7–3.9 [3.7–3.8]	4.0–4.2 [4.1–4.4] ([4.5–4.7])	[4.1–4.4] ([4.5–4.7])	–
Combined (xDrive)	l/100 km	5.6–5.8	5.6–5.9 [5.2–5.4]	[5.5–5.7]	((6.2–6.4))	4.1–4.3 [3.9–4.1]	4.4–4.6 [4.5–4.7] ([4.7–5.0])	[4.4–4.6] ([4.8–5.0])	((1.8–2.0))
Consumption range, combined	kWh/100 km	–	–	–	–	–	–	–	((13.5–14.2))
Exhaust emissions standard (type-certified) (xDrive)		EU6d	EU6d	EU6d	EU6d	EU6d	EU6d	EU6d	EU6d
Combined CO ₂ emissions (xDrive)	g/km	129–134	129–134 [120–124]	[125–131]	((141–146))	108–112 [102–107]	117–123 [117–123] ([125–131])	[116–122] ([127–132])	((41–47))
Tank capacity, approx.	l	51	51	51	51	51	51	51	36

Wheels/tyres									
Tyre dimensions		205/60 R16 W	205/60 R16 W	205/60 R16 W	205/55 R17 W	205/60 R16 W	205/60 R16 W	205/60 R16 W	205/55 R17 W
Wheel size		7J x 16	7J x 16	7J x 16	7.5J x 17	7J x 16	7J x 16	7J x 16	7.5J x 17
Material		Light alloy	Light alloy	Light alloy	Light alloy	Light alloy	Light alloy	Light alloy	Light alloy

BMW 2 SERIES GRAN TOURER.						
	216i	218i	220i	216d	218d 218d xDrive	220d 220d xDrive

Weight							
Unladen weight EU (xDrive) 5-seater 7-seater ¹	kg	1500 1550	1505 1555 [1530 1580]	[1570 1620]	1565 1610 [1580 1615]	1600 1650 [1620 1680] ([1690 1740])	[1635 1685] ([1695 1745])
Max. permissible weight (xDrive) 5-seater 7-seater	kg	2055 2160	2060 2155 [2090 2180]	[2140 2235]	2130 2220 [2155 2225]	2165 2265 [2200 2300] ([2260 2360])	[2220 2310] ([2280 2375])
Permitted load (xDrive) 5-seater 7-seater	kg	630 685	630 675 [635 675]	[645 690]	640 685 [650 685]	640 690 [655 695] ([645 695])	[660 700] ([660 705])
Permitted trailer load, unbraked (xDrive) 5-seater 7-seater ²	kg	750 750	750 750 [750 750]	[750 750]	750 750 [750 750]	750 750 [750 750] ([750 750])	[750 750] ([750 750])
Permitted trailer load, braked, max. 12% gradient/max. 8% gradient (xDrive) 5-seater 7-seater ²	kg	1100/1100 1100/1100	1500/1500 1500/1500 [1500/1500] [1500/1500]	[1500/1500] [1500/1500]	1500/1500 1500/1500 [1500/1500] [1500/1500]	1500/1500 1500/1500 [1500/1500] [1500/1500] ([1600/1600] [1600/1600])	[1500/1500] [1500/1500] ([1600/1600] [1600/1600])
Luggage capacity	l	645–1905 560–1820	645–1905 560–1820	645–1905 560–1820	645–1905 560–1820	645–1905 560–1820	645–1905 560–1820

BMW TwinPower Turbo engine ⁴							
Cylinders/valves		3/4	3/4	4/4	3/4	4/4	4/4
Capacity	cm ³	1499	1499	1998	1496	1995	1995
Max. output/engine speed	kW (hp)/rpm	80 (109)/4300–6500	100 (136)/4500–6600	131 (178)/5000–5500	85 (116)/4000	110–100 (150–136)/4000	140 (190)/4000
Max. torque/engine speed	Nm/rpm	190/1380–3800	220/1500–4100	280/1350–4200	270/1750–2250	350/1750–2500	400/1750–2500

Power transmission							
Type of drive (xDrive)		Front-wheel	Front-wheel	Front-wheel	Front-wheel	Front-wheel	Front-wheel
Standard transmission (xDrive)		6-speed manual	6-speed manual	7-speed DCT	6-speed manual	6-speed manual (8-speed Steptronic)	8-speed Steptronic (8-speed Steptronic)

Performance							
Top speed (xDrive) 5-seater 7-seater	km/h	188 188	205 205 [205 205]	[222 222]	192 192 [192 192]	198 207 [200 207] ([205 205])	[220 220] ([218 218])
Acceleration 0–100 km/h (xDrive) 5-seater 7-seater	s	11.7 11.9	9.5 9.8 [9.6 9.8]	[7.5 7.7]	11.5 11.8 [11.5 11.8]	9.4 10.0 [9.4 10.0] ([9.4 9.6])	[8.0 8.2] ([7.8 8.0])

Consumption ^{4,5} – All engines conform to the EU6 standard							
Urban (xDrive) 5-seater 7-seater	l/100 km	7.2–7.3 7.3–7.5	7.2–7.5 7.4–7.7 [6.5–6.5 6.5–6.5]	[7.0–7.1 7.1–7.2]	4.8–5.0 4.8–5.0 [4.5–4.8 4.5–4.8]	5.2–5.5 5.4–5.7 [5.1–5.2 5.1–5.3] ([5.2–5.5 5.4–5.7])	[5.0–5.2 5.0–5.2] ([5.4–5.6 5.5–5.8])
Extra-urban (xDrive) 5-seater 7-seater	l/100 km	4.9–5.1 5.0–5.3	4.9–5.1 5.0–5.2 [4.8–5.1 4.8–5.1]	[4.9–5.2 5.0–5.3]	3.9–4.1 3.9–4.1 [3.8–4.0 3.8–4.0]	4.2–4.4 4.2–4.4 [4.3–4.6 4.4–4.6] ([4.6–4.8 4.7–4.9])	[4.4–4.6 4.4–4.6] ([4.6–4.8 4.7–4.9])
Combined (xDrive) 5-seater 7-seater	l/100 km	5.7–6.0 5.9–6.1	5.7–6.0 5.9–6.1 [5.4–5.6 5.4–5.7]	[5.7–5.9 5.8–6.0]	4.2–4.4 4.2–4.4 [4.1–4.3 4.1–4.3]	4.6–4.8 4.7–4.9 [4.6–4.8 4.6–4.9] ([4.8–5.1 4.9–5.2])	[4.6–4.8 4.6–4.8] ([4.9–5.1 5.0–5.2])
Exhaust emissions standard (type-certified)		EU6d	EU6d	EU6d	EU6d	EU6d	EU6d
Combined CO ₂ emissions (xDrive) 5-seater 7-seater	g/km	132–137 135–140	132–137 135–140 [124–129 125–130]	[130–136 133–139]	112–117 112–117 [107–112 107–112]	120–126 123–129 [121–128 122–128] ([127–133 130–136])	[121–127 121–128] ([129–135 132–138])
Tank capacity, approx.	l	51	51	51	51	51	51

Wheels/tyres							
Tyre dimensions		205/60 R16 W	205/60 R16 W	205/55 R17 W	205/60 R16 W	205/55 R17 W	205/55 R17 W
Wheel size		7J x 16	7J x 16	7.5J x 17	7J x 16	7.5J x 17	7.5J x 17
Material		Light alloy	Light alloy	Light alloy	Light alloy	Light alloy	Light alloy

Figures in [] are for vehicles with Steptronic transmission.

¹ The EC unladen weight refers to a vehicle with standard equipment and does not include any optional extras. The unladen weight includes a 90% full tank and a driver weight of 75 kg. Optional equipment may affect the weight of the vehicle, the payload and the top speed if the selected equipment has an impact on the vehicle's aerodynamics.
² The actual total weight of the trailer must not exceed the maximum permitted trailer load, taking into account the maximum tow bar download.
³ Range depends on various factors. In particular: personal driving style, route characteristics, exterior temperature, heating/air conditioning, pre-conditioning and the chosen equipment.
⁴ Performance data of petrol engines apply to vehicles using RON 98 fuel. Fuel consumption data apply to vehicles using reference fuels in accordance with EU Regulation 2007/715. Unleaded RON 91 and higher with a maximum ethanol content of 10% (E10) may also be used. BMW recommends RON 95 super unleaded petrol.
⁵ The official data for fuel consumption and CO₂ emissions were determined in accordance with the measurement processes as defined by European Regulation (EU) 715/2007 in the applicable version. The ranges take into account differences in the selected wheel and tyre size. Figures have been determined on the basis of the new WLTP test cycle and have been converted back into NEDC figures for comparability. Values other than those specified here may apply for the assessment of taxes and other vehicle-related charges that are (also) based on CO₂ emissions.
⁶ Dependent on the local electricity infrastructure. Charging time corresponds to an 100% charge of maximum capacity.
⁷ Provisional figures; any missing figures were unavailable at the time of publication.



YOUR NEW SPEED DATING APP.

DOWNLOAD NOW THE BMW BROCHURES APP FROM YOUR APP STORE AND DISCOVER DRIVING PLEASURE!

BMW 220i ACTIVE TOURER WITH SPORT LINE:

BMW TwinPower Turbo 4-cylinder petrol engine, 131 kW (178 hp), 18" light alloy wheels Star-spoke style 512, exterior colour in Sunset orange metallic, seats in Cloth/Sensatec combination Anthracite with orange accent, interior trim finishers in Aluminium, finely brushed lengthwise with highlight trim finisher Pearl Chrome.

BMW 220d xDRIVE GRAN TOURER WITH M SPORT PACKAGE:

BMW TwinPower Turbo 4-cylinder diesel engine, 140 kW (190 hp), 18" M light alloy wheels Double-spoke style 486 M, exterior colour in M Misano Blue metallic, seats in leather 'Dakota' Black with highlight in Blue, M interior trim finishers in Aluminium Hexagon with highlight trim finisher Pearl Chrome.

The models illustrated in this medium show the equipment and configuration options (standard and optional) for vehicles produced by BMW AG for the German market. Alterations in standard and optional equipment and the configurations available for the different models, as described in this medium, may occur after 11/11/2020, the editorial deadline for this medium, or according to the specific requirements of other member states of the European Union. Your local BMW Partner is available to provide further details. Subject to change in design and equipment.

Of course, each vehicle is designed for economical recycling after its long-running life. You can find more information regarding your end-of-life vehicle on our website www.bmw.de/recycling
© BMW AG, Munich, Germany. Not to be reproduced wholly or in part without prior written permission of BMW AG, Munich.

411 002 030 20 1 2021 CB. Printed in Germany 2021.